



TECHNICAL DATASHEET

TOPLA ENERGY E66H

ORDER INFORMATION

TAB ID

1000208

Short Code

E66H

DIN Marking

56649

EAN Code

3838807027459

Quantity per EU/CNT pallet

63/90 pcs

TECHNOLOGY

Primary Function

Engine Start

Battery Technology

Flooded

Grid Type (pos/neg)

Expanded/Concasted

Grid Alloy (pos/neg)

Ca/Ca

Separator

PE

Electrolyte (g/cm³)

1,28

TECHNICAL INFORMATION

Voltage (V)

12

Capacity C20 (Ah)

66

CCA -18°C EN (A)

620

RC (min)

112

LxWxH (mm)

242x175x190

Total Weight (kg)

15.0

BOX DESIGN

Box Type

L2

Cover Type

Kamina

Colour

Red

Layout

0

BHD

B13

Terminal

1

DRAWING

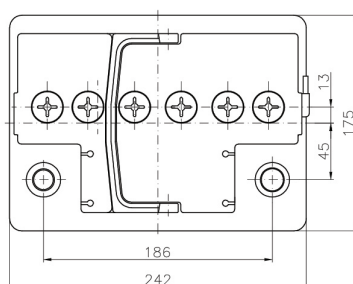
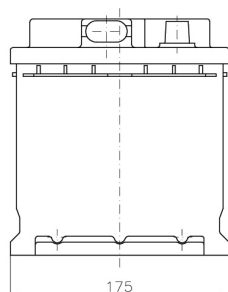
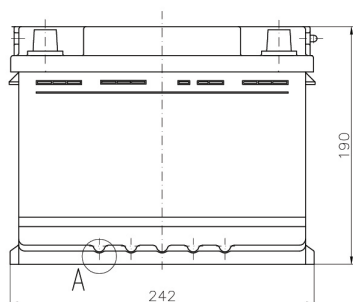

BHD



LAYOUT

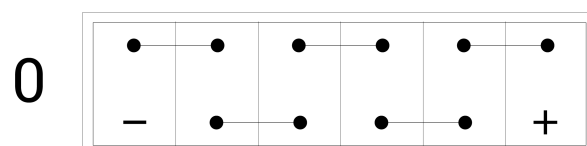

TERMINAL

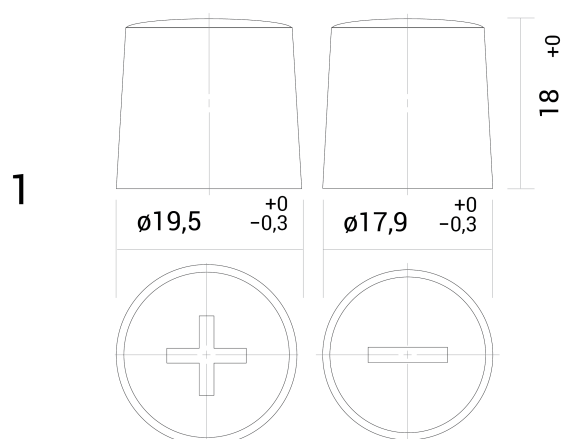

TECHNICAL DATASHEET

TOPLA ENERGY E66H