

TECHNICAL DATASHEET

TOPLA EFB STOP&GO TSG10JX

ORDER INFORMATION

TAB ID

1000244

Short Code

TSG10JX

DIN Marking

60519 EFB

EAN Code

3838807038585

Quantity per EU/CNT pallet

42/70 pcs

TECHNOLOGY

Primary Function

Start/Stop Functionality

Battery Technology

EFB - Enhanced Flooded Battery

Grid Type (pos/neg)

Expanded/Concasted

Grid Alloy (pos/neg)

Ca/Ca

Separator

PE

Electrolyte (g/cm³)

1,28

TECHNICAL INFORMATION

Voltage (V)

12

Capacity C20 (Ah)

105

CCA -18°C EN (A)

900

RC (min)

192

LxWxH (mm)

306x173x200/221

Total Weight (kg)

23.3

BOX DESIGN

Box Type

D31

Cover Type

SMF

Colour

Black

Layout

1

BHD

B01

Terminal

1

DRAWING

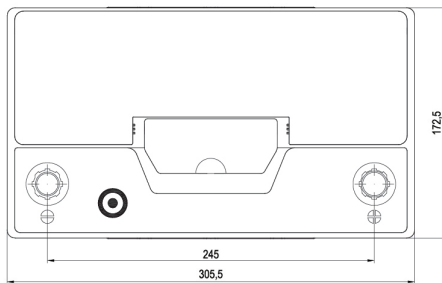

BHD



LAYOUT

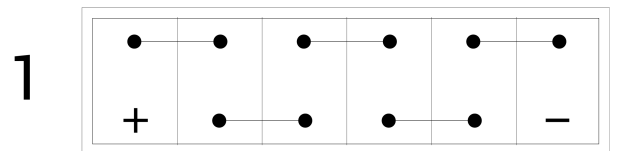

TERMINAL

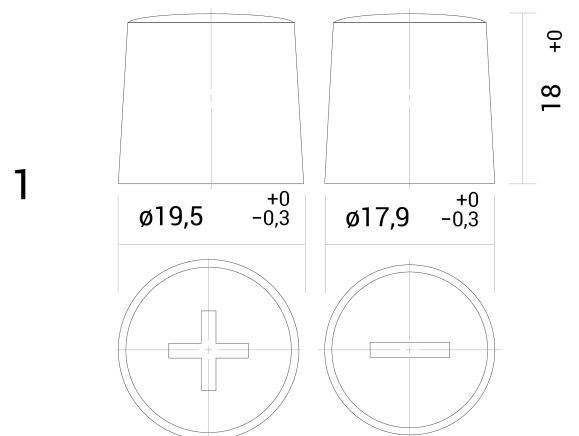

TECHNICAL DATASHEET

TOPLA EFB STOP&GO TSG10JX

TAB d.d, Polena 6, SI-2392 Mežica, Slovenia, www.tab.si