



TECHNICAL DATASHEET

TOPLA AGM STOP&GO TAG95

ORDER INFORMATION

TAB ID

1000264

Short Code

TAG95

DIN Marking

L5 AGM

EAN Code

3838807036345

Quantity per EU/CNT pallet

36/60 pcs

TECHNOLOGY

Primary Function

Advanced Start/Stop Functionality

Battery Technology

AGM - Absorbent Glass Mat

Grid Type (pos/neg)

Casted/Concasted

Grid Alloy (pos/neg)

Ca/Ca

Separator

GM

Electrolyte (g/cm³)

1,3

TECHNICAL INFORMATION

Voltage (V)

12

Capacity C20 (Ah)

95

CCA -18°C EN (A)

850

RC (min)

184

LxWxH (mm)

353x175x190

Total Weight (kg)

26.0

BOX DESIGN

Box Type

L5

Cover Type

Sealed

Colour

Black

Layout

0

BHD

B13

Terminal

1

DRAWING

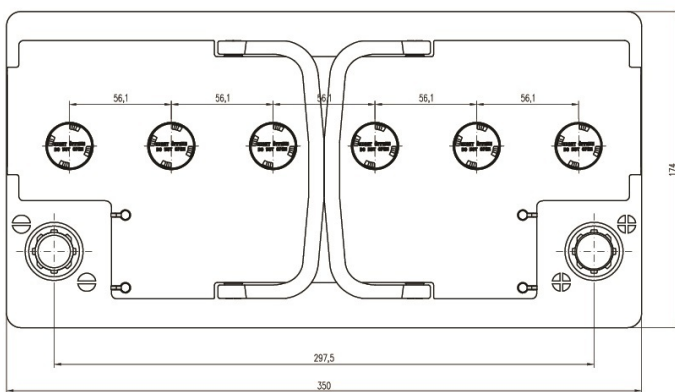
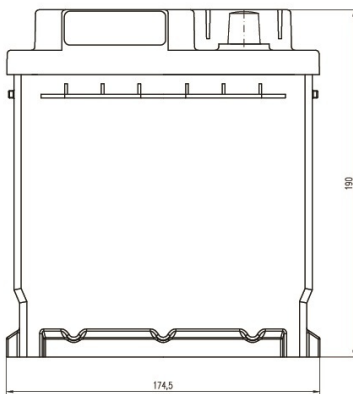
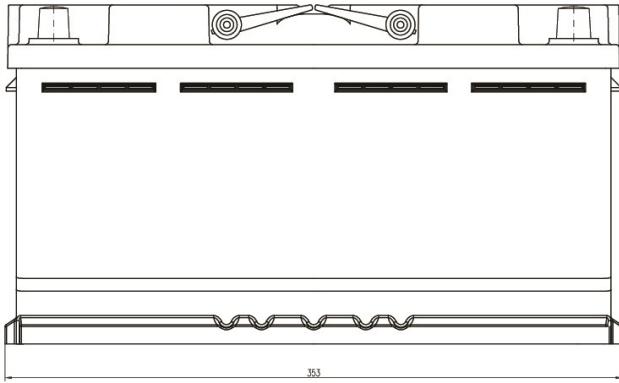

BHD



LAYOUT



TERMINAL

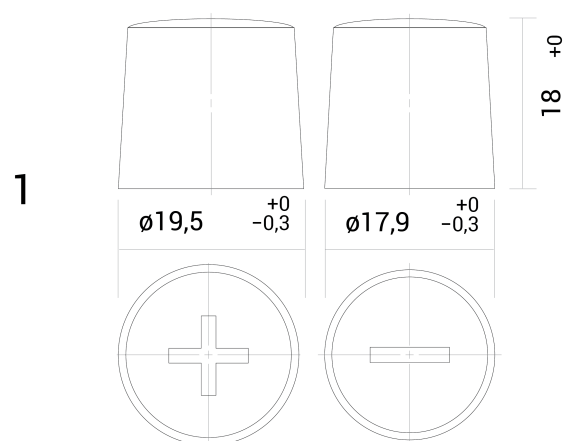

TECHNICAL DATASHEET

TOPLA AGM STOP&GO TAG95