

TECHNICAL DATASHEET

TAB POLAR TRUCK TR11

ORDER INFORMATION

TAB ID
1000291

Short Code
TR11

DIN Marking
61028

EAN Code
3838807031654

Quantity per EU/CNT pallet
36/48 pcs

TECHNOLOGY

Primary Function
Engine Start

Battery Technology
Flooded

Grid Type (pos/neg)
Expanded/Concasted

Grid Alloy (pos/neg)
Ca/Ca

Separator
PE

Electrolyte (g/cm³)
1,28

TECHNICAL INFORMATION

Voltage (V)
12

Capacity C20 (Ah)
110

CCA -18°C EN (A)
800

RC (min)
203

LxWxH (mm)
345x172x218/238

Total Weight (kg)
26.5

BOX DESIGN

Box Type
60528

Cover Type
Flat

Colour
Black

Layout
0

BHD
B0

Terminal
1

DRAWING

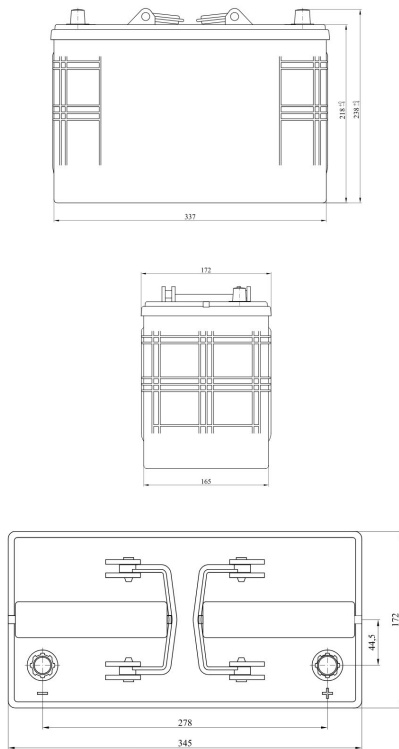

BHD



LAYOUT

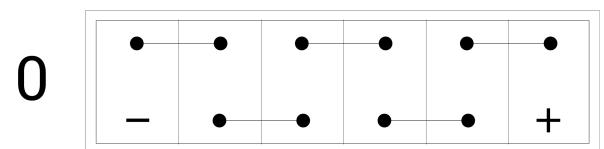

TERMINAL

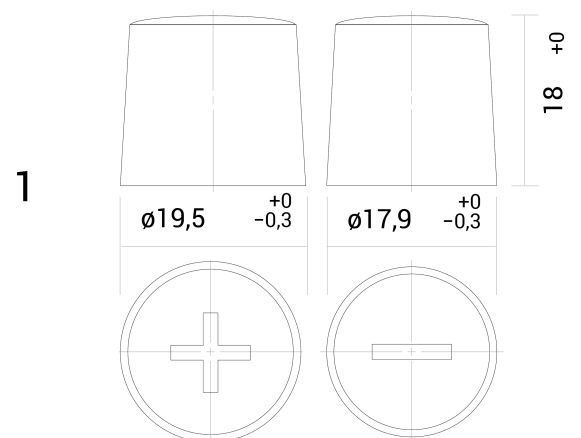

TECHNICAL DATASHEET

TAB POLAR TRUCK TR11