

TECHNICAL DATASHEET

TOPLA TOP JIS TT45JX

ORDER INFORMATION

TAB ID

1000303

Short Code

TT45JX

DIN Marking

54522 SMF

EAN Code

3838807030459

Quantity per EU/CNT pallet

96/128 pcs

TECHNOLOGY

Primary Function

Engine Start

Battery Technology

Flooded

Grid Type (pos/neg)

Expanded/Concasted

Grid Alloy (pos/neg)

Ca/Ca

Separator

PE

Electrolyte (g/cm³)

1,28

TECHNICAL INFORMATION

Voltage (V)

12

Capacity C20 (Ah)

45

CCA -18°C EN (A)

360

RC (min)

71

LxWxH (mm)

196x134x202/223

Total Weight (kg)

10.6

BOX DESIGN

Box Type

B19

Cover Type

SMF

Colour

Black

Layout

1

BHD

B01

Terminal

1

DRAWING

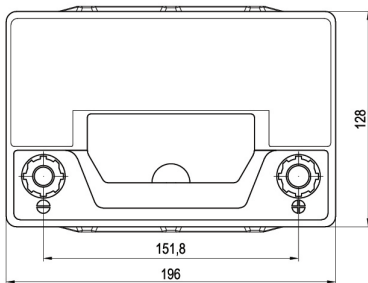
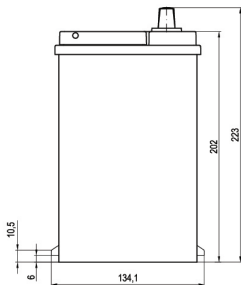
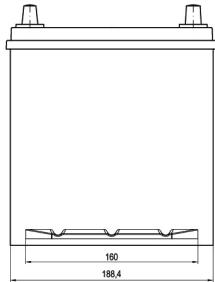

BHD



LAYOUT

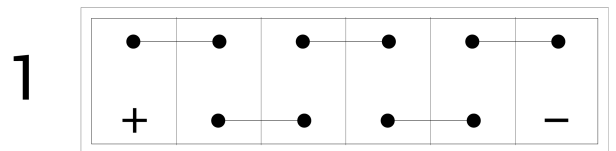

TERMINAL

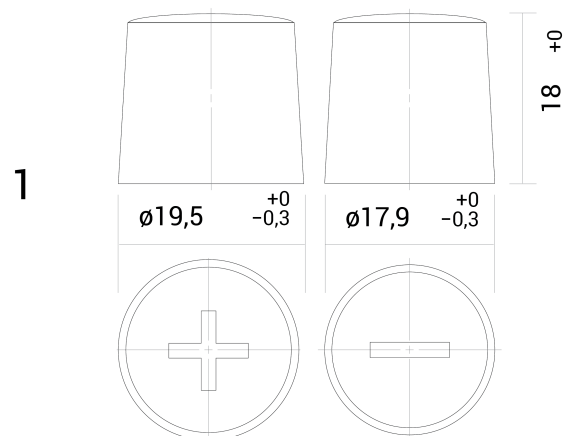

TECHNICAL DATASHEET

TOPLA TOP JIS TT45JX