



TECHNICAL DATASHEET

TOPLA TOP JIS TT35J

ORDER INFORMATION

TAB ID

1000324

Short Code

TT35J

DIN Marking

53520 SMF

EAN Code

3838807030411

Quantity per EU/CNT pallet

96/128 pcs

TECHNOLOGY

Primary Function

Engine Start

Battery Technology

Flooded

Grid Type (pos/neg)

Expanded/Concasted

Grid Alloy (pos/neg)

Ca/Ca

Separator

PE

Electrolyte (g/cm³)

1,28

TECHNICAL INFORMATION

Voltage (V)

12

Capacity C20 (Ah)

35

CCA -18°C EN (A)

270

RC (min)

53

LxWxH (mm)

196x128x202/223

Total Weight (kg)

9.4

BOX DESIGN

Box Type

B19

Cover Type

SMF

Colour

Black

Layout

0

BHD

B0

Terminal

3

DRAWING

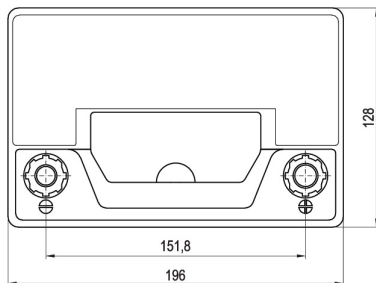
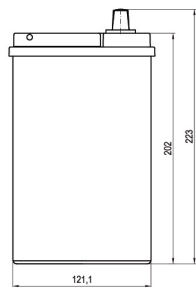
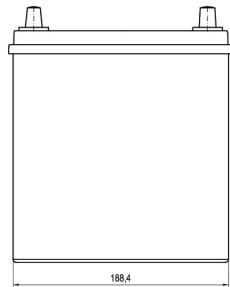

BHD

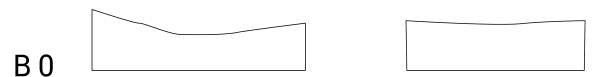

LAYOUT

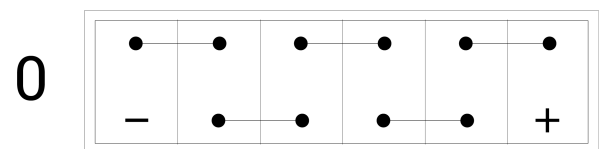

TERMINAL

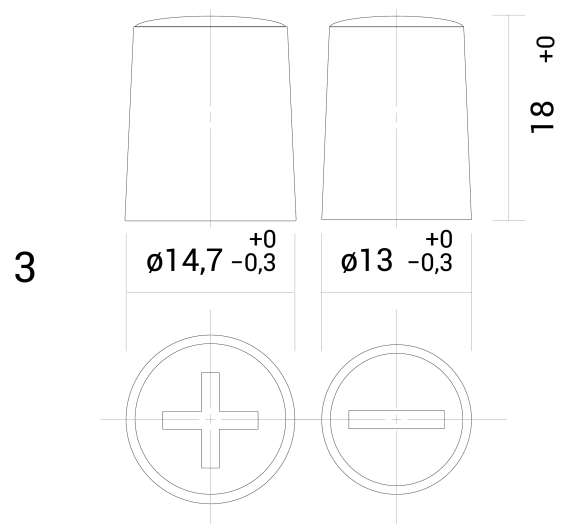

TECHNICAL DATASHEET

TOPLA TOP JIS TT35J