



# TECHNICAL DATASHEET

## TAB POLAR TRUCK TR19

### ORDER INFORMATION

TAB ID  
**1000495**

Short Code  
**TR19**

DIN Marking  
**69032**

EAN Code  
**3838807040632**

Quantity per EU/CNT pallet  
**21/28 pcs**

### TECHNOLOGY

Primary Function  
**Engine Start**

Battery Technology  
**Flooded**

Grid Type (pos/neg)  
**Casted/Concasted**

Grid Alloy (pos/neg)  
**Sb/Ca**

Separator  
**PE**

Electrolyte (g/cm<sup>3</sup>)  
**1,28**

### TECHNICAL INFORMATION

Voltage (V)  
**12**

Capacity C20 (Ah)  
**190**

CCA -18°C EN (A)  
**1200**

RC (min)  
**385**

LxWxH (mm)  
**512×223×194/216**

Total Weight (kg)  
**42.8**

### BOX DESIGN

Box Type  
**B**

Cover Type  
**Flat**

Colour  
**Black**

Layout  
**3**

BHD  
**B0**

Terminal  
**1**

## DRAWING

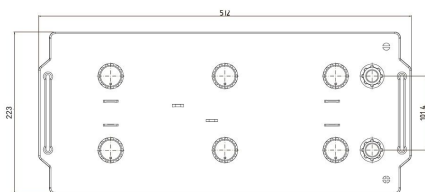
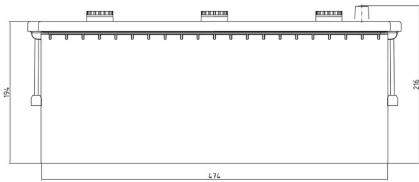

## BHD



## LAYOUT

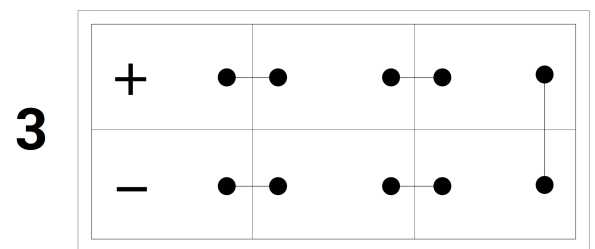

## TERMINAL

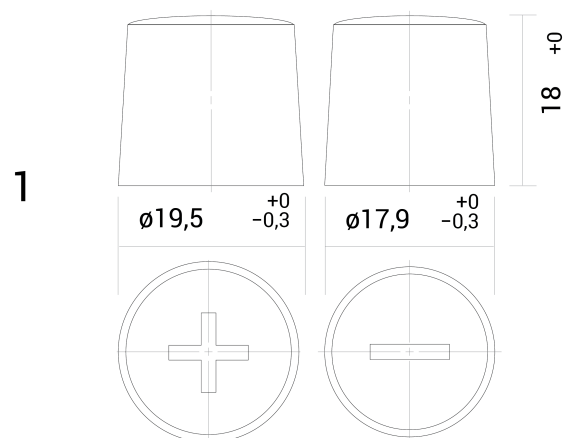

# TECHNICAL DATASHEET

## TAB POLAR TRUCK TR19