



TECHNICAL DATASHEET

VESNA POWER TRUCK VT18

ORDER INFORMATION

TAB ID

1000566

Short Code

VT18

DIN Marking

68032

EAN Code

3838807042599

Quantity per EU/CNT pallet

21/28 pcs

TECHNOLOGY

Primary Function

Engine Start

Battery Technology

Flooded

Grid Type (pos/neg)

Casted/Concasted

Grid Alloy (pos/neg)

Sb/Ca

Separator

PE

Electrolyte (g/cm³)

1,28

TECHNICAL INFORMATION

Voltage (V)

12

Capacity C20 (Ah)

180

CCA -18°C EN (A)

1100

RC (min)

361

LxWxH (mm)

512x222x194/221

Total Weight (kg)

43.3

BOX DESIGN

Box Type

B

Cover Type

Flat

Colour

Black

Layout

3

BHD

B0

Terminal

1

DRAWING

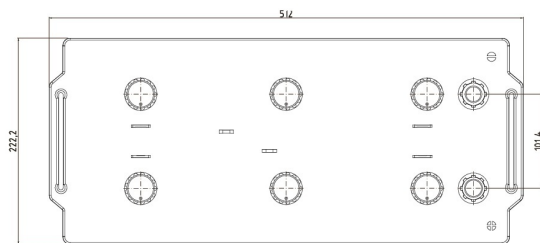
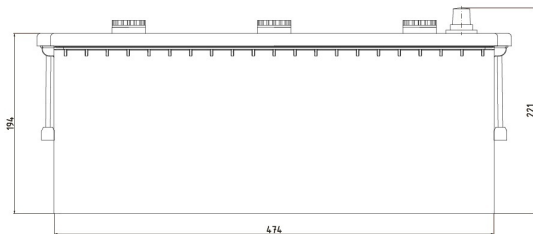

BHD



LAYOUT

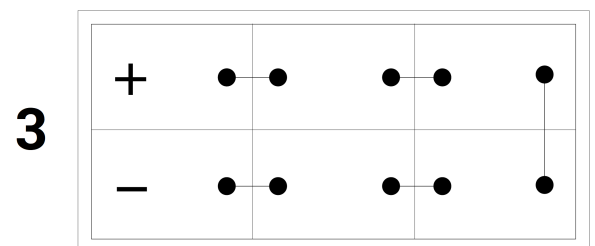

TERMINAL

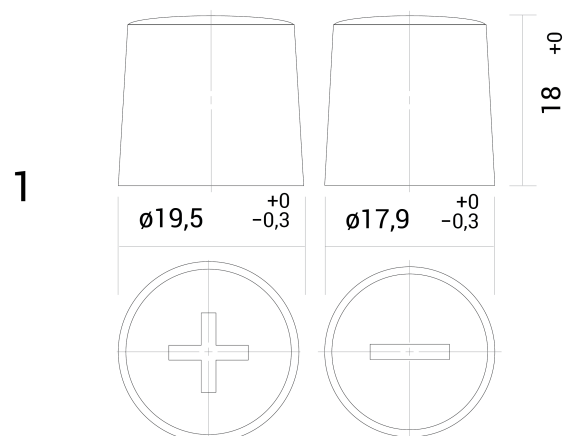

TECHNICAL DATASHEET

VESNA POWER TRUCK VT18