

TECHNICAL DATASHEET

TAB EFB STOP&GO SG70JX

ORDER INFORMATION

TAB ID
1000795

Short Code
SG70JX

DIN Marking
57024 EFB

EAN Code
3838807047693

Quantity per EU/CNT pallet
48/80 pcs

TECHNOLOGY

Primary Function
Start/Stop Functionality

Battery Technology
EFB - Enhanced Flooded Battery

Grid Type (pos/neg)
Expanded/Concasted

Grid Alloy (pos/neg)
Ca/Ca

Separator
PE

Electrolyte (g/cm³)
1,28

TECHNICAL INFORMATION

Voltage (V)
12

Capacity C20 (Ah)
70

CCA -18°C EN (A)
680

RC (min)
120

LxWxH (mm)
259x175x200/221

Total Weight (kg)
19.6

BOX DESIGN

Box Type
D26

Cover Type
SMF

Colour
Black

Layout
1

BHD
B1

Terminal
1

DRAWING

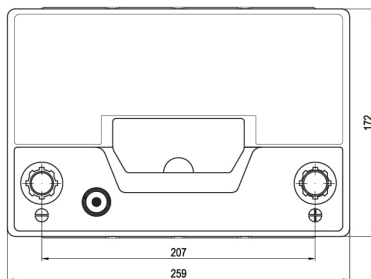
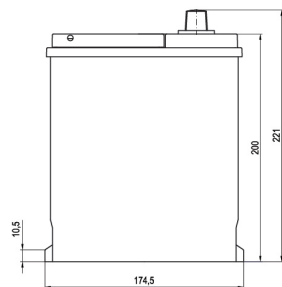
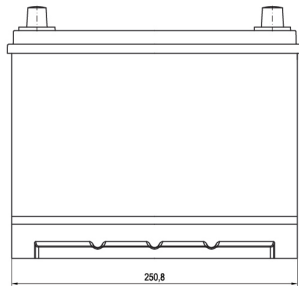

BHD



LAYOUT

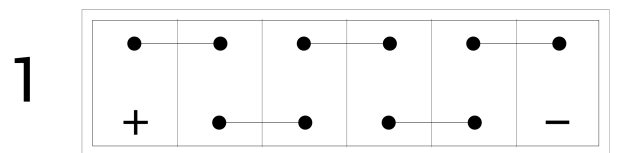

TERMINAL

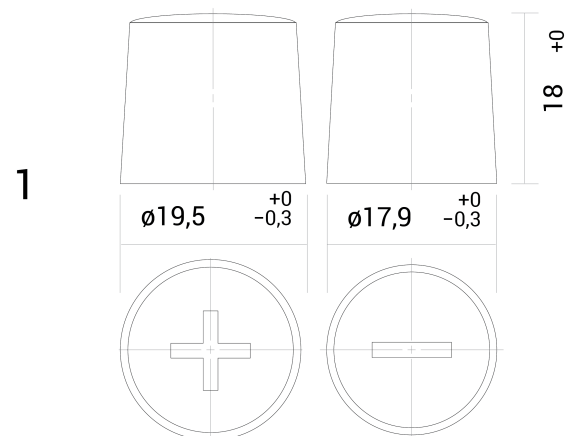

TECHNICAL DATASHEET

TAB EFB STOP&GO SG70JX

TAB d.d, Polena 6, SI-2392 Mežica, Slovenia, www.tab.si