



TECHNICAL DATASHEET

TAB AGM STOP&GO AG60

ORDER INFORMATION

TAB ID

1000799

Short Code

AG60

DIN Marking

L2 AGM

EAN Code

3838807008533

Quantity per EU/CNT pallet

63/90 pcs

TECHNOLOGY

Primary Function

Advanced Start/Stop Functionality

Battery Technology

AGM - Absorbent Glass Mat

Grid Type (pos/neg)

Casted/Concasted

Grid Alloy (pos/neg)

Ca/Ca

Separator

GM

Electrolyte (g/cm³)

1,3

TECHNICAL INFORMATION

Voltage (V)

12

Capacity C20 (Ah)

60

CCA -18°C EN (A)

680

RC (min)

109

LxWxH (mm)

242x175x190

Total Weight (kg)

17.9

BOX DESIGN

Box Type

L2

Cover Type

Sealed

Colour

Black

Layout

0

BHD

B13

Terminal

1

DRAWING

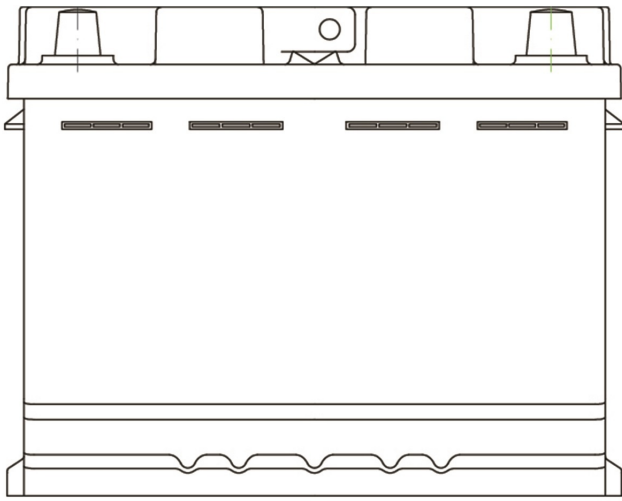

BHD

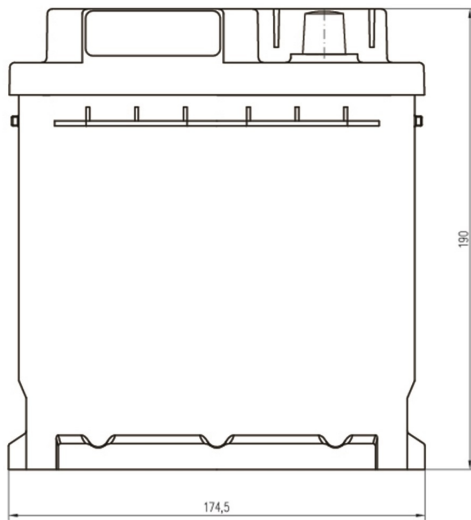

LAYOUT

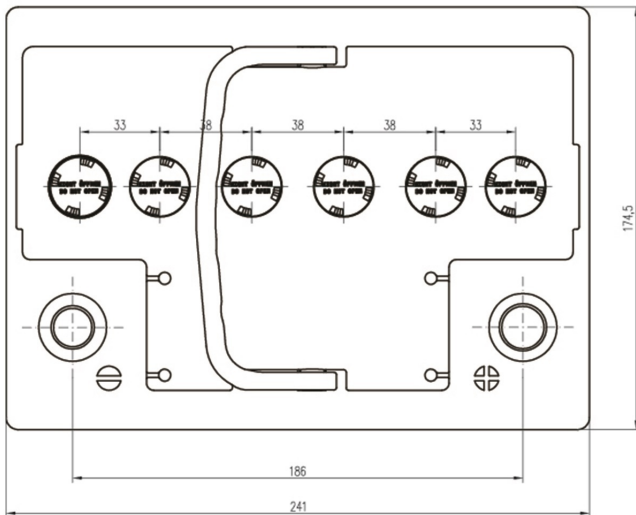
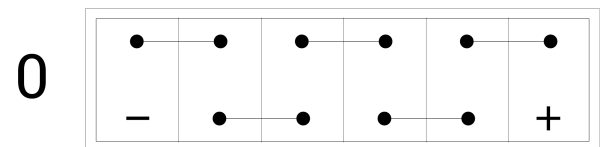

TERMINAL

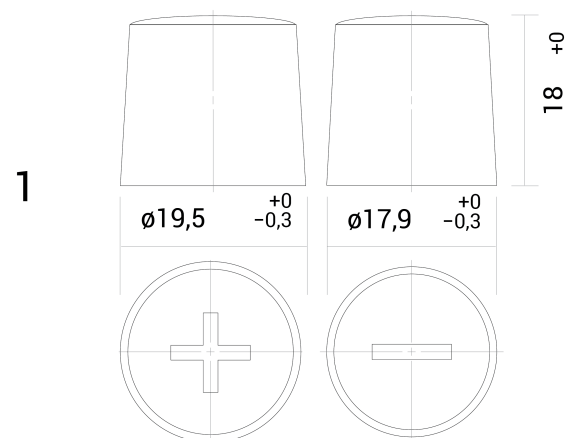

TECHNICAL DATASHEET

TAB AGM STOP&GO AG60