



TECHNICAL DATASHEET

TAB AGM STOP&GO AG75X

ORDER INFORMATION

TAB ID

1000806

Short Code

AG75X

DIN Marking

57024 AGM

EAN Code

3838807051423

Quantity per EU/CNT pallet

48/80 pcs

TECHNOLOGY

Primary Function

Advanced Start/Stop Functionality

Battery Technology

AGM - Absorbent Glass Mat

Grid Type (pos/neg)

Casted/Concasted

Grid Alloy (pos/neg)

Ca/Ca

Separator

GM

Electrolyte (g/cm³)

1,3

TECHNICAL INFORMATION

Voltage (V)

12

Capacity C20 (Ah)

75

CCA -18°C EN (A)

750

RC (min)

140

LxWxH (mm)

263x173x200/221

Total Weight (kg)

20.4

BOX DESIGN

Box Type

D26

Cover Type

Sealed

Colour

Black

Layout

1

BHD

B1

Terminal

1

DRAWING

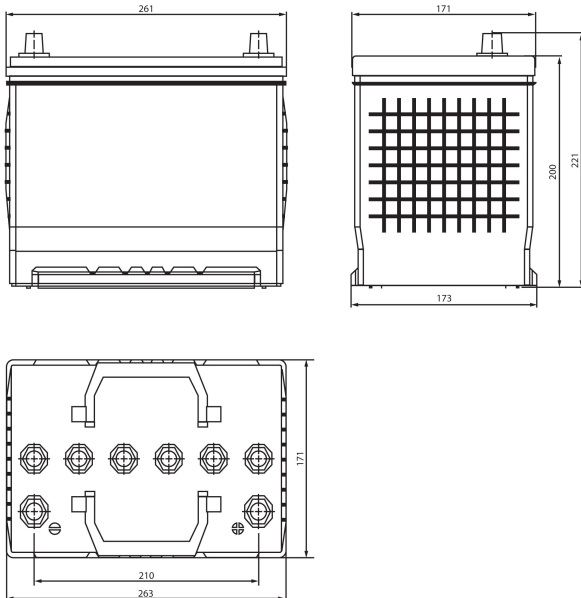

BHD

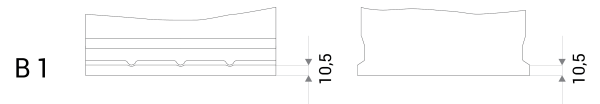

LAYOUT

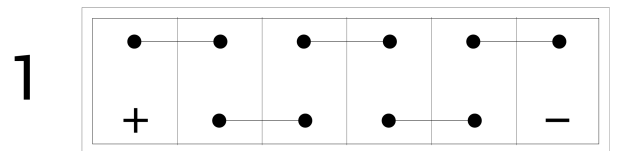

TERMINAL

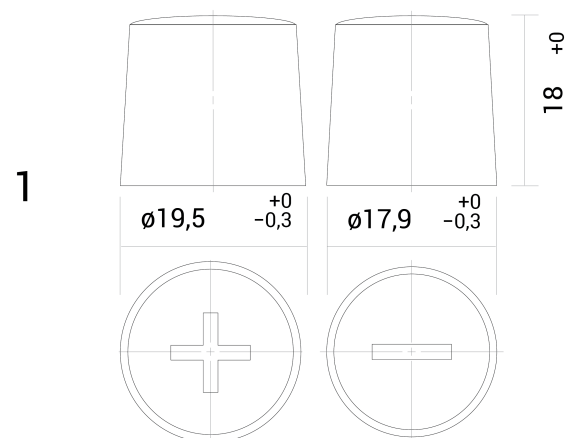

TECHNICAL DATASHEET

TAB AGM STOP&GO AG75X

TAB d.d, Polena 6, SI-2392 Mežica, Slovenia, www.tab.si