



TECHNICAL DATASHEET

TAB POLAR S45

ORDER INFORMATION

TAB ID
1000865

Short Code
S45

DIN Marking
54502 SMF

EAN Code
3838807026919

Quantity per EU/CNT pallet
72/120 pcs

TECHNOLOGY

Primary Function
Engine Start

Battery Technology
Flooded

Grid Type (pos/neg)
Expanded/Concasted

Grid Alloy (pos/neg)
Ca/Ca

Separator
PE

Electrolyte (g/cm³)
1,28

TECHNICAL INFORMATION

Voltage (V)
12

Capacity C20 (Ah)
45

CCA -18°C EN (A)
420

RC (min)
71

LxWxH (mm)
207x175x175

Total Weight (kg)
11.1

BOX DESIGN

Box Type
L1B

Cover Type
SMF

Colour
Black

Layout
0

BHD
B13

Terminal
1

DRAWING

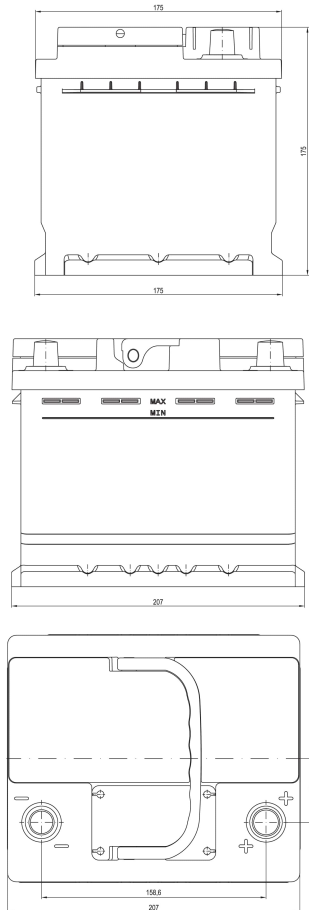

BHD

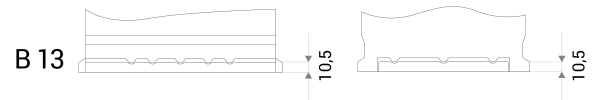

LAYOUT

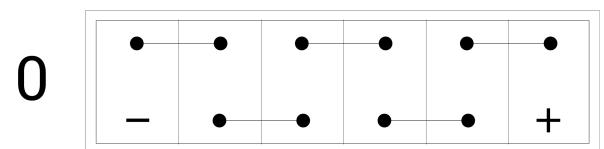

TERMINAL

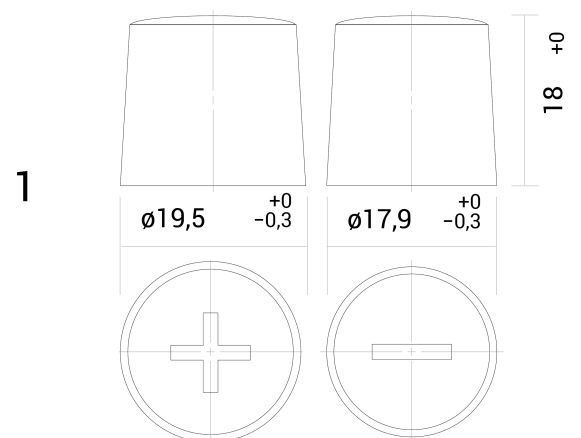

TECHNICAL DATASHEET

TAB POLAR S45