



TECHNICAL DATASHEET

TAB POLAR P50

ORDER INFORMATION

TAB ID
1000881

Short Code
P50

DIN Marking
55001 SMF

EAN Code
3838807033603

Quantity per EU/CNT pallet
63/108 pcs

TECHNOLOGY

Primary Function
Engine Start

Battery Technology
Flooded

Grid Type (pos/neg)
Expanded/Concasted

Grid Alloy (pos/neg)
Ca/Ca

Separator
PE

Electrolyte (g/cm³)
1,28

TECHNICAL INFORMATION

Voltage (V)
12

Capacity C20 (Ah)
50

CCA -18°C EN (A)
450

RC (min)
81

LxWxH (mm)
242x175x175

Total Weight (kg)
12.6

BOX DESIGN

Box Type
L2B

Cover Type
SMF

Colour
Black

Layout
0

BHD
B13

Terminal
1

DRAWING

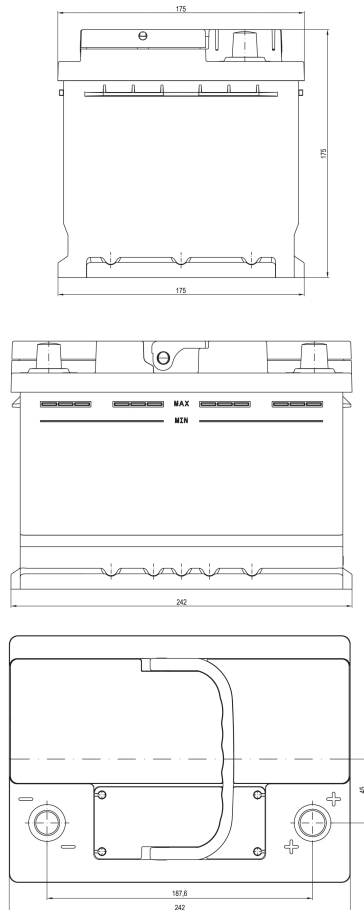

BHD

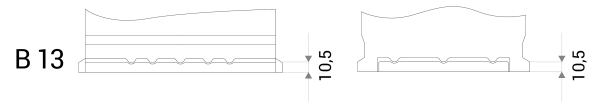

LAYOUT

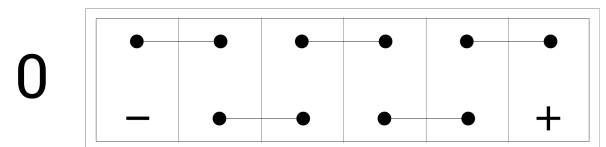

TERMINAL

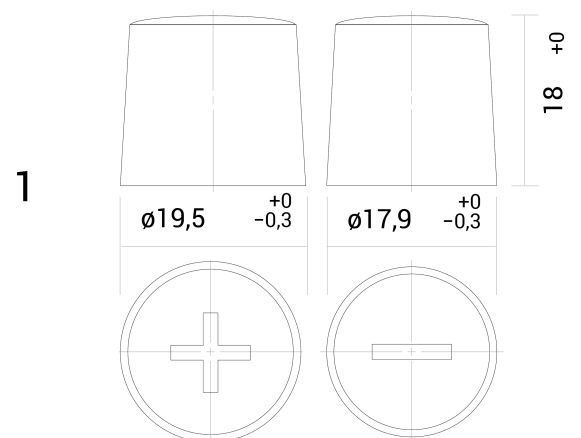

TECHNICAL DATASHEET

TAB POLAR P50