



TECHNICAL DATASHEET

VESNA EFB STOP&GO VSG90

ORDER INFORMATION

TAB ID
313090

Short Code
VSG90

DIN Marking
59088 EFB

EAN Code
3838807032743

Quantity per EU/CNT pallet
36/60 pcs

TECHNOLOGY

Primary Function
Start/Stop Functionality

Battery Technology
EFB - Enhanced Flooded Battery

Grid Type (pos/neg)
Expanded/Concasted

Grid Alloy (pos/neg)
Ca/Ca

Separator
PE

Electrolyte (g/cm³)
1,28

TECHNICAL INFORMATION

Voltage (V)
12

Capacity C20 (Ah)
90

CCA -18°C EN (A)
850

RC (min)
161

LxWxH (mm)
353x175x190

Total Weight (kg)
24.6

BOX DESIGN

Box Type
L5

Cover Type
SMF

Colour
Black

Layout
0

BHD
B13

Terminal
1

DRAWING

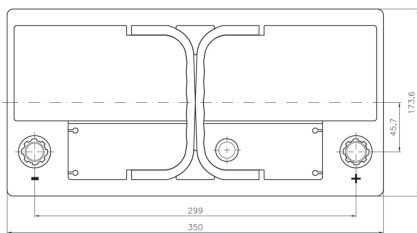
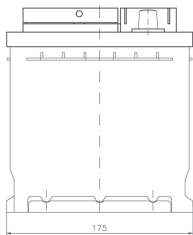
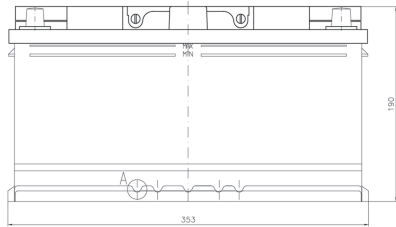

BHD

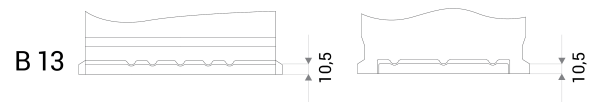

LAYOUT

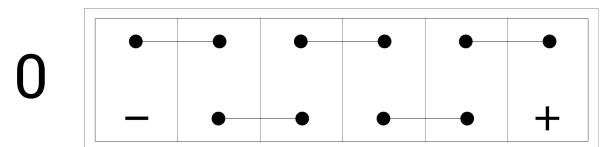

TERMINAL

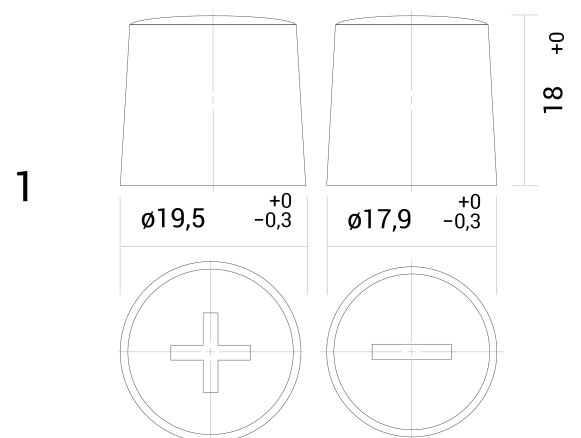

TECHNICAL DATASHEET

VESNA EFB STOP&GO VSG90

TAB d.d, Polena 6, SI-2392 Mežica, Slovenia, www.tab.si