

TECHNICAL DATASHEET

VESNA EFB STOP&GO VSG70JX

ORDER INFORMATION

TAB ID

313770

Short Code

VSG70JX

DIN Marking

57024 EFB

EAN Code

3838807047754

Quantity per EU/CNT pallet

48/80 pcs

TECHNOLOGY

Primary Function

Start/Stop Functionality

Battery Technology

EFB - Enhanced Flooded Battery

Grid Type (pos/neg)

Expanded/Concasted

Grid Alloy (pos/neg)

Ca/Ca

Separator

PE

Electrolyte (g/cm³)

1,28

TECHNICAL INFORMATION

Voltage (V)

12

Capacity C20 (Ah)

70

CCA -18°C EN (A)

680

RC (min)

120

LxWxH (mm)

259x175x200/221

Total Weight (kg)

19.6

BOX DESIGN

Box Type

D26

Cover Type

SMF

Colour

Black

Layout

1

BHD

B1

Terminal

1

DRAWING

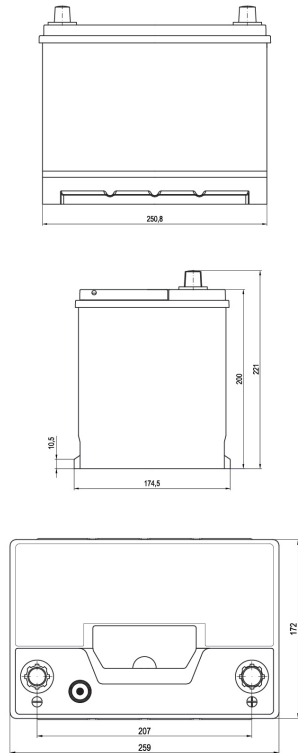

BHD

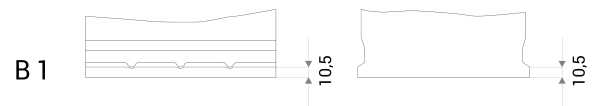

LAYOUT

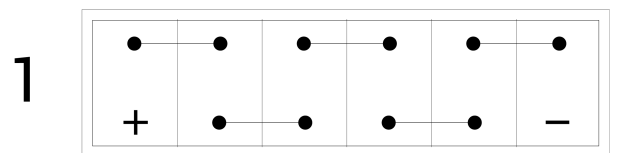

TERMINAL

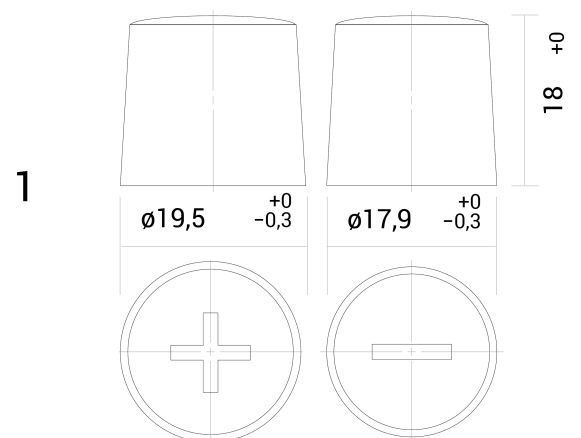

TECHNICAL DATASHEET

VESNA EFB STOP&GO VSG70JX

TAB d.d, Polena 6, SI-2392 Mežica, Slovenia, www.tab.si