



## TECHNICAL DATASHEET

### VESNA AGM STOP&GO VAG60

#### ORDER INFORMATION

TAB ID

**1001390**

Short Code

**VAG60**

DIN Marking

**L2 AGM**

EAN Code

**3838807032712**

Quantity per EU/CNT pallet

**63/90 pcs**

#### TECHNOLOGY

Primary Function

**Advanced Start/Stop Functionality**

Battery Technology

**AGM - Absorbent Glass Mat**

Grid Type (pos/neg)

**Casted/Concasted**

Grid Alloy (pos/neg)

**Ca/Ca**

Separator

**GM**

Electrolyte (g/cm<sup>3</sup>)

**1,3**

#### TECHNICAL INFORMATION

Voltage (V)

**12**

Capacity C20 (Ah)

**60**

CCA -18°C EN (A)

**680**

RC (min)

**109**

LxWxH (mm)

**242x175x190**

Total Weight (kg)

**17.9**

#### BOX DESIGN

Box Type

**L2**

Cover Type

**Sealed**

Colour

**Black**

Layout

**0**

BHD

**B13**

Terminal

**1**

DRAWING

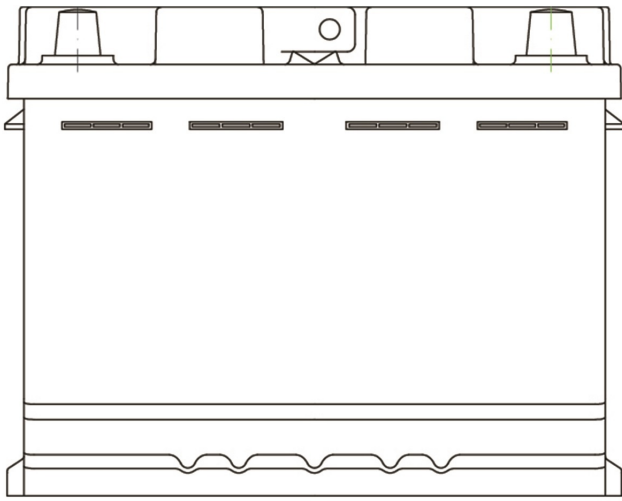

## BHD

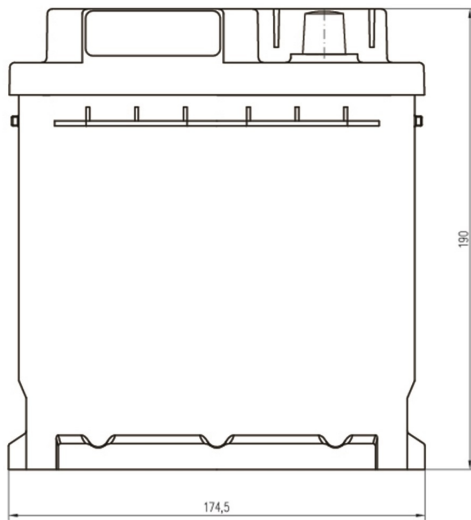

## LAYOUT

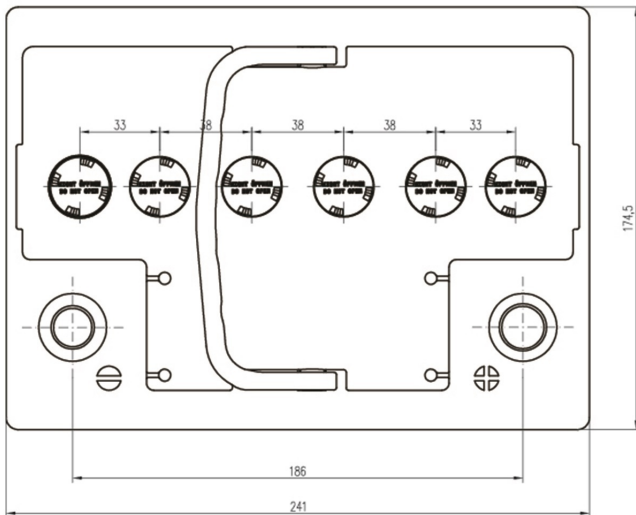
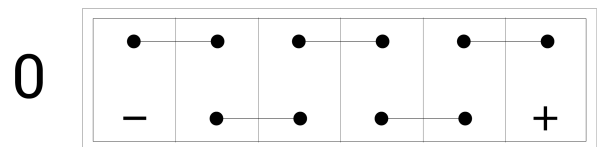

## TERMINAL

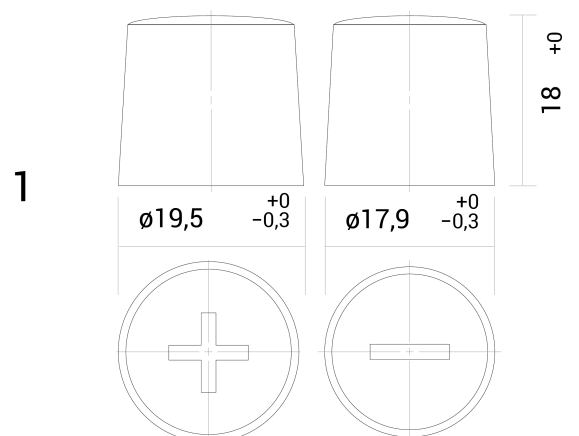

# TECHNICAL DATASHEET

## VESNA AGM STOP&GO VAG60