



TECHNICAL DATASHEET

VESNA AGM STOP&GO VAG70

ORDER INFORMATION

TAB ID

1001391

Short Code

VAG70

DIN Marking

L3 AGM

EAN Code

3838807032729

Quantity per EU/CNT pallet

51/80 pcs

TECHNOLOGY

Primary Function

Advanced Start/Stop Functionality

Battery Technology

AGM - Absorbent Glass Mat

Grid Type (pos/neg)

Casted/Concasted

Grid Alloy (pos/neg)

Ca/Ca

Separator

GM

Electrolyte (g/cm³)

1,3

TECHNICAL INFORMATION

Voltage (V)

12

Capacity C20 (Ah)

70

CCA -18°C EN (A)

760

RC (min)

130

LxWxH (mm)

278x175x190

Total Weight (kg)

20.5

BOX DESIGN

Box Type

L3

Cover Type

Sealed

Colour

Black

Layout

0

BHD

B13

Terminal

1

DRAWING

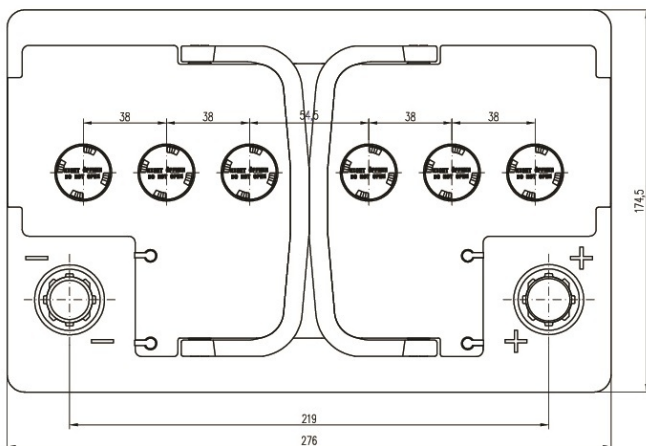
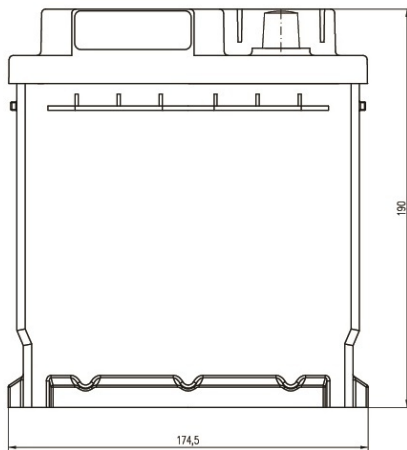
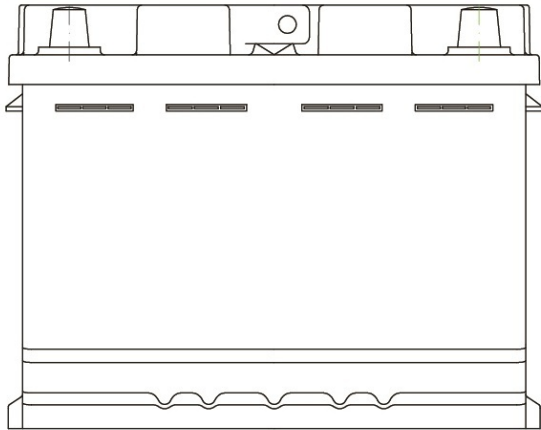

BHD

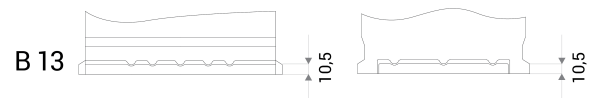

LAYOUT



TERMINAL



TECHNICAL DATASHEET

VESNA AGM STOP&GO VAG70

TAB d.d, Polena 6, SI-2392 Mežica, Slovenia, www.tab.si