

TECHNICAL DATASHEET

VESNA HR – HOT REGION MF50B24L(S)

ORDER INFORMATION

TAB ID
615245

Short Code
MF50B24L(S)

DIN Marking

EAN Code
3838807041318

Quantity per EU/CNT pallet
0/168 pcs

TECHNOLOGY

Primary Function
Engine Start

Battery Technology
Flooded

Grid Type (pos/neg)
Expanded/Concasted

Grid Alloy (pos/neg)
Ca/Ca

Separator
PE

Electrolyte (g/cm³)
1,28

TECHNICAL INFORMATION

Voltage (V)
12

Capacity C20 (Ah)
45

CCA -18°C EN (A)
360

RC (min)
71

LxWxH (mm)
236x128x202/223

Total Weight (kg)
11.9

BOX DESIGN

Box Type
B24

Cover Type
SMF

Colour
Black

Layout
0

BHD
B0

Terminal
3

DRAWING

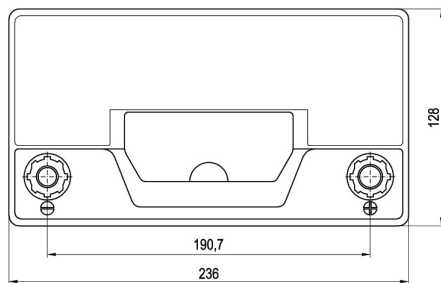
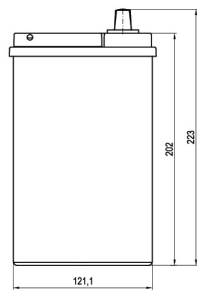
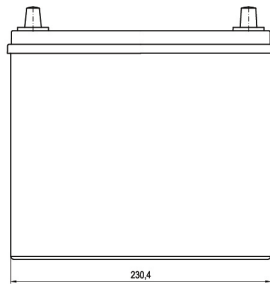

BHD



LAYOUT

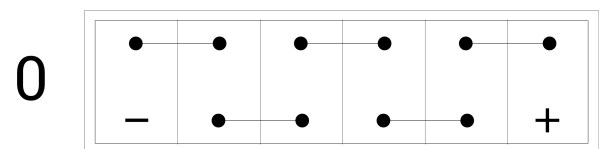

TERMINAL

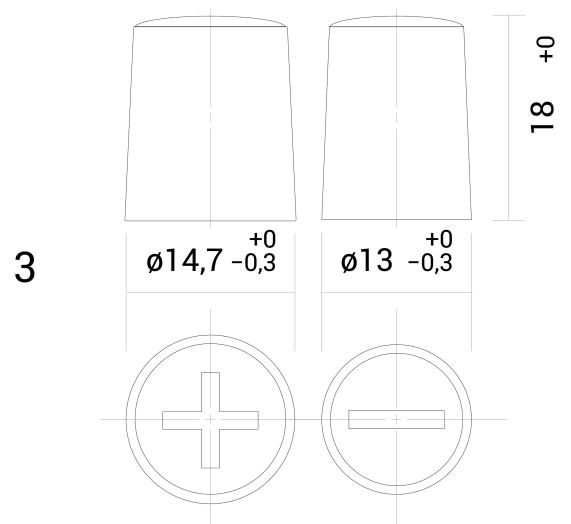

TECHNICAL DATASHEET

VESNA HR – HOT REGION MF50B24L(S)