

TECHNICAL DATASHEET

VESNA HR – HOT REGION MF65D31L

ORDER INFORMATION

TAB ID
615270

Short Code
MF65D31L

DIN Marking

EAN Code
3838807041776

Quantity per EU/CNT pallet
0/108 pcs

TECHNOLOGY

Primary Function
Engine Start

Battery Technology
Flooded

Grid Type (pos/neg)
Expanded/Concasted

Grid Alloy (pos/neg)
Ca/Ca

Separator
PE

Electrolyte (g/cm³)
1,28

TECHNICAL INFORMATION

Voltage (V)
12

Capacity C20 (Ah)
70

CCA -18°C EN (A)
520

RC (min)
120

LxWxH (mm)
306x173x200/221

Total Weight (kg)
18.4

BOX DESIGN

Box Type
D31

Cover Type
SMF

Colour
Black

Layout
0

BHD
B01

Terminal
1

DRAWING



BHD



LAYOUT

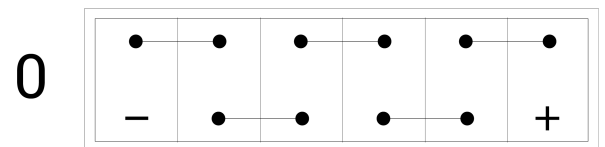

TERMINAL

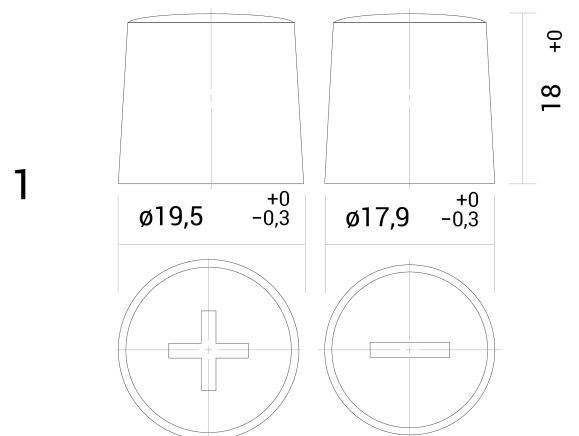

TECHNICAL DATASHEET

VESNA HR – HOT REGION MF65D31L