

TECHNICAL DATASHEET

VESNA HR – HOT REGION L4 AGM

ORDER INFORMATION

TAB ID
615480

Short Code
L4 AGM

DIN Marking

EAN Code
3838807042308

Quantity per EU/CNT pallet
0/90 pcs

TECHNOLOGY

Primary Function
Advanced Start/Stop Functionality

Battery Technology
AGM - Absorbent Glass Mat

Grid Type (pos/neg)
Casted/Concasted

Grid Alloy (pos/neg)
Ca/Ca

Separator
GM

Electrolyte (g/cm³)
1,3

TECHNICAL INFORMATION

Voltage (V)
12

Capacity C20 (Ah)
80

CCA -18°C EN (A)
800

RC (min)
151

LxWxH (mm)
315x175x190

Total Weight (kg)
23.2

BOX DESIGN

Box Type
L4

Cover Type
Sealed

Colour
Black

Layout
0

BHD
B13

Terminal
1

DRAWING

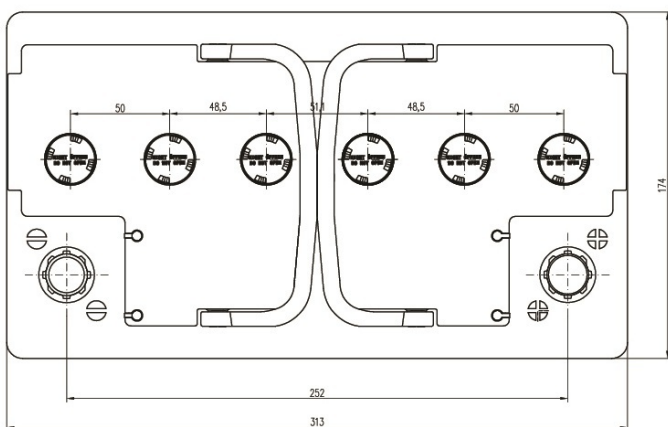
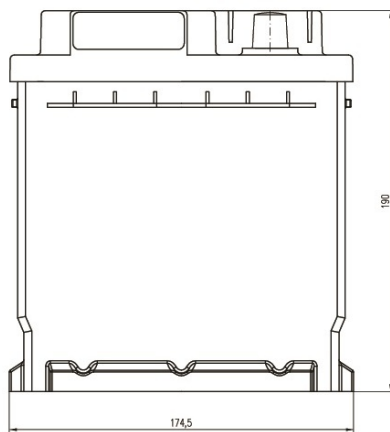
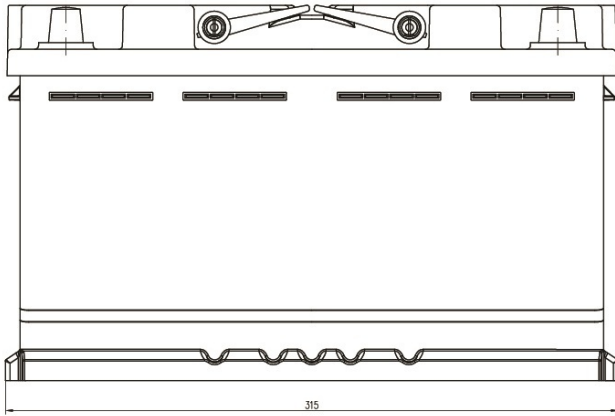

BHD



LAYOUT



TERMINAL



TECHNICAL DATASHEET

VESNA HR – HOT REGION L4 AGM