

TECHNICAL DATASHEET

VESNA HR – HOT REGION MF55B24R(S)

ORDER INFORMATION

TAB ID

615945

Short Code

MF55B24R(S)

DIN Marking

EAN Code

3838807041295

Quantity per EU/CNT pallet

0/168 pcs

TECHNOLOGY

Primary Function

Engine Start

Battery Technology

Flooded

Grid Type (pos/neg)

Expanded/Concasted

Grid Alloy (pos/neg)

Ca/Ca

Separator

PE

Electrolyte (g/cm³)

1,28

TECHNICAL INFORMATION

Voltage (V)

12

Capacity C20 (Ah)

45

CCA -18°C EN (A)

360

RC (min)

71

LxWxH (mm)

236x128x202/223

Total Weight (kg)

11.9

BOX DESIGN

Box Type

B24

Cover Type

SMF

Colour

Black

Layout

1

BHD

B0

Terminal

3

DRAWING

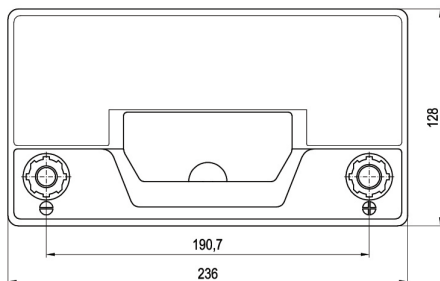
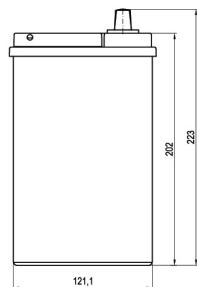
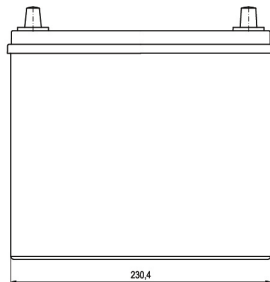

BHD

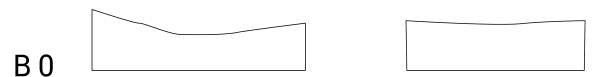

LAYOUT



TERMINAL

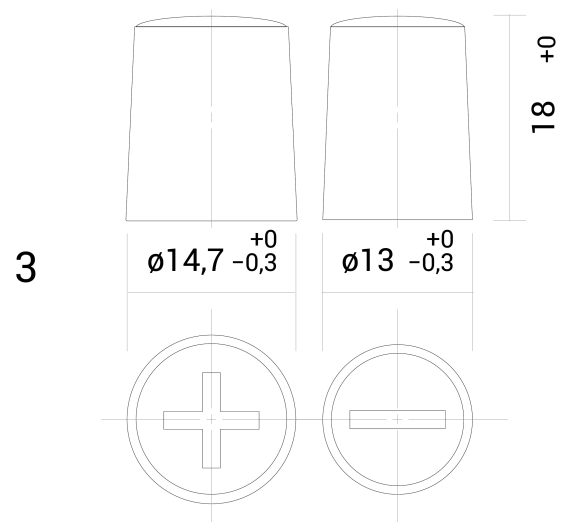

TECHNICAL DATASHEET

VESNA HR – HOT REGION MF55B24R(S)