

TECHNICAL DATASHEET

TOPLA HR - HOT REGION MF48D26L

ORDER INFORMATION

TAB ID

Short Code
MF48D26L

DIN Marking

EAN Code
3838807045934

Quantity per EU/CNT pallet
0/140 pcs

TECHNOLOGY

Primary Function
Engine Start

Battery Technology
Flooded

Grid Type (pos/neg)
Expanded/Concasted

Grid Alloy (pos/neg)
Ca/Ca

Separator
PE

Electrolyte (g/cm³)
1,28

TECHNICAL INFORMATION

Voltage (V)
12

Capacity C20 (Ah)
50

CCA -18°C EN (A)
400

RC (min)
81

LxWxH (mm)
259x175x200/221

Total Weight (kg)
15.0

BOX DESIGN

Box Type
D26

Cover Type
SMF

Colour
Black

Layout
0

BHD
B1

Terminal
1

DRAWING

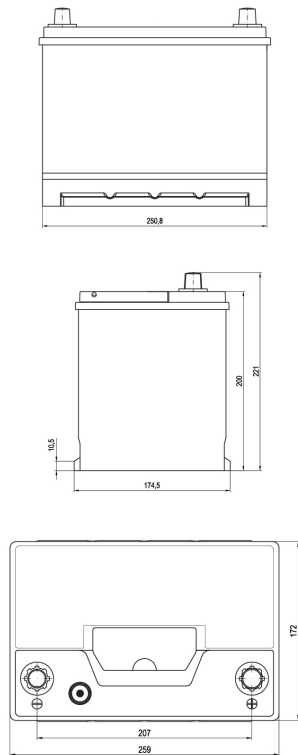

BHD

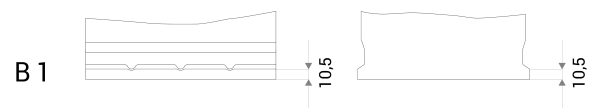

LAYOUT

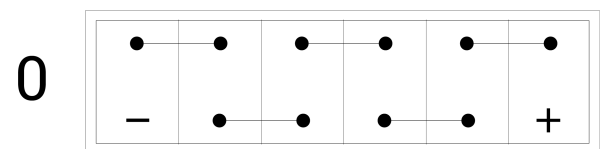

TERMINAL

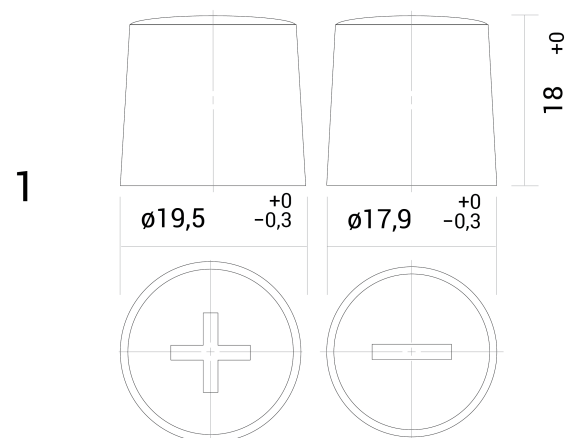

TECHNICAL DATASHEET

TOPLA HR - HOT REGION MF48D26L

TAB d.d, Polena 6, SI-2392 Mežica, Slovenia, www.tab.si