

# TECHNICAL DATASHEET

## TOPLA EFB STOP&GO TSG10JX

### ORDER INFORMATION

TAB ID

**1000244**

Short Code

**TSG10JX**

DIN Marking

**60519 EFB**

EAN Code

**3838807038585**

Quantity per EU/CNT pallet

**42/70 pcs**

### TECHNOLOGY

Primary Function

**Start/Stop Functionality**

Battery Technology

**EFB - Enhanced Flooded Battery**

Grid Type (pos/neg)

**Expanded/Concasted**

Grid Alloy (pos/neg)

**Ca/Ca**

Separator

**PE**

Electrolyte (g/cm<sup>3</sup>)

**1,28**

### TECHNICAL INFORMATION

Voltage (V)

**12**

Capacity C20 (Ah)

**105**

CCA -18°C EN (A)

**900**

RC (min)

**192**

LxWxH (mm)

**306x173x200/221**

Total Weight (kg)

**23.3**

### BOX DESIGN

Box Type

**D31**

Cover Type

**SMF**

Colour

**Black**

Layout

**1**

BHD

**B01**

Terminal

**1**

## DRAWING

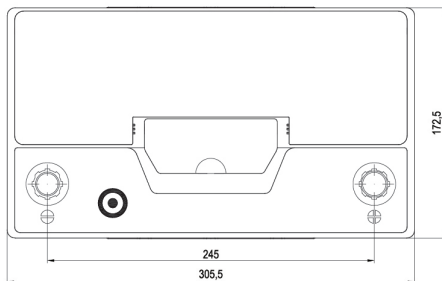
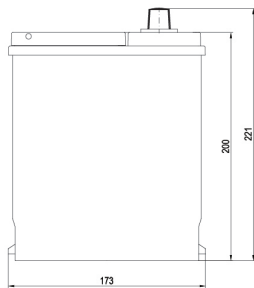
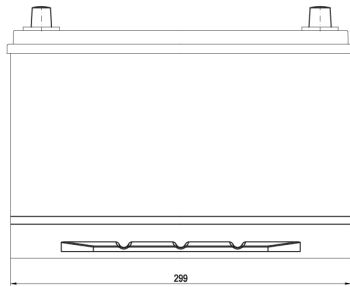

## BHD

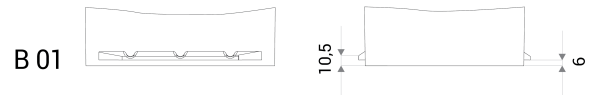

## LAYOUT

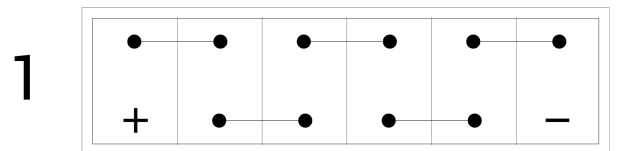

## TERMINAL

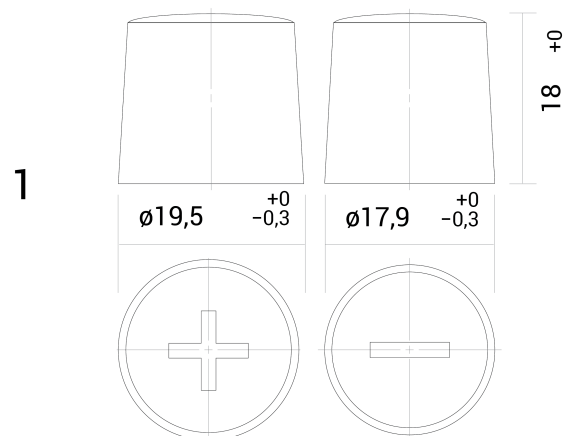

# TECHNICAL DATASHEET

## TOPLA EFB STOP&GO TSG10JX

TAB d.d, Polena 6, SI-2392 Mežica, Slovenia, [www.tab.si](http://www.tab.si)