



TECHNICAL DATASHEET

TOPLA AGM STOP&GO TAG95

ORDER INFORMATION

TAB ID
114090

Short Code
TAG95

DIN Marking
L5 AGM

EAN Code
3838807036345

Quantity per EU/CNT pallet
36/60 pcs

TECHNOLOGY

Primary Function
Advanced Start/Stop Functionality

Battery Technology
AGM - Absorbent Glass Mat

Grid Type (pos/neg)
Casted/Concasted

Grid Alloy (pos/neg)
Ca/Ca

Separator
GM

Electrolyte (g/cm³)
1,3

TECHNICAL INFORMATION

Voltage (V)
12

Capacity C20 (Ah)
95

CCA -18°C EN (A)
850

RC (min)
184

LxWxH (mm)
353x175x190

Total Weight (kg)
26.0

BOX DESIGN

Box Type
L5

Cover Type
Sealed

Colour
Black

Layout
0

BHD
B13

Terminal
1

DRAWING

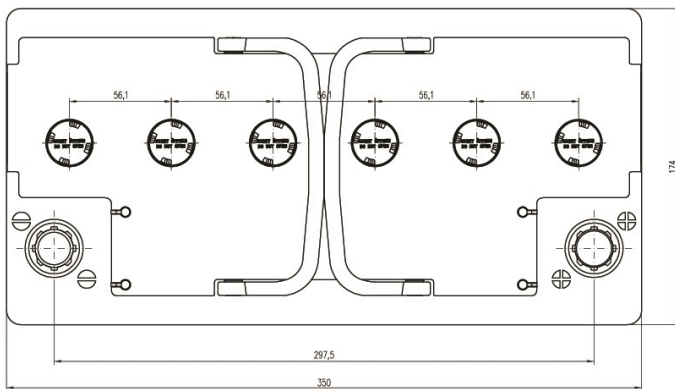
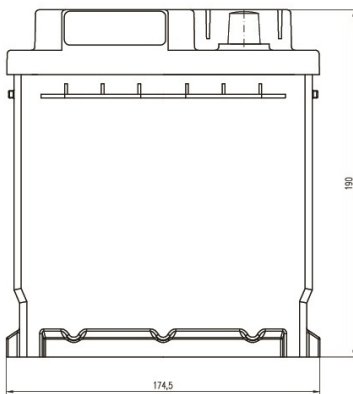
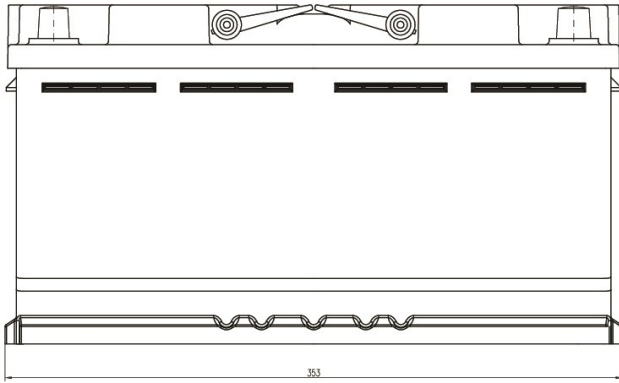

BHD



LAYOUT



TERMINAL



TECHNICAL DATASHEET

TOPLA AGM STOP&GO TAG95

TAB d.d, Polena 6, SI-2392 Mežica, Slovenia, www.tab.si