



TECHNICAL DATASHEET

VESNA POWER TRUCK VT17

ORDER INFORMATION

TAB ID

1000516

Short Code

VT17

DIN Marking

67018

EAN Code

3838807042575

Quantity per EU/CNT pallet

21/28 pcs

TECHNOLOGY

Primary Function

Engine Start

Battery Technology

Flooded

Grid Type (pos/neg)

Casted/Concasted

Grid Alloy (pos/neg)

Sb/Ca

Separator

PE

Electrolyte (g/cm³)

1,28

TECHNICAL INFORMATION

Voltage (V)

12

Capacity C20 (Ah)

170

CCA -18°C EN (A)

1050

RC (min)

338

LxWxH (mm)

512x222x194/221

Total Weight (kg)

42.7

BOX DESIGN

Box Type

B

Cover Type

Flat

Colour

Black

Layout

3

BHD

B0

Terminal

1

DRAWING

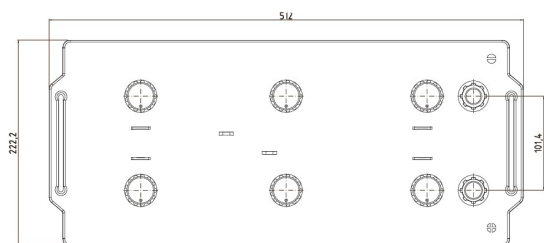
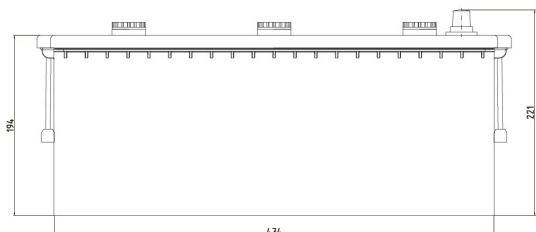

BHD



LAYOUT

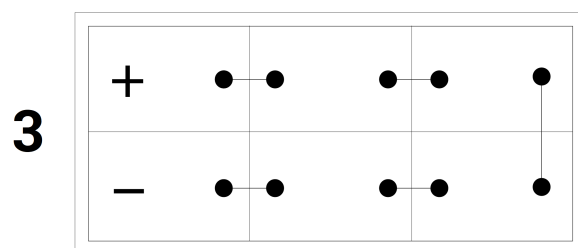

TERMINAL

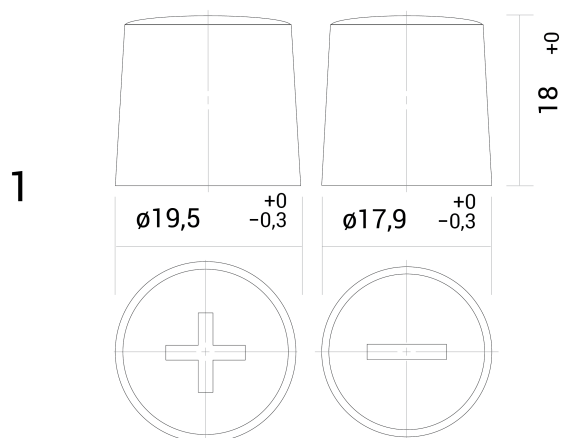

TECHNICAL DATASHEET

VESNA POWER TRUCK VT17