



TECHNICAL DATASHEET

TAB MOWER U1-32

ORDER INFORMATION

TAB ID

1000826

Short Code

U1-32

DIN Marking

EAN Code

3838807035621

Quantity per EU/CNT pallet

96/128 pcs

TECHNOLOGY

Primary Function

Engine Start

Battery Technology

Flooded

Grid Type (pos/neg)

Expanded/Expanded

Grid Alloy (pos/neg)

Ca/Ca

Separator

PE

Electrolyte (g/cm³)

1,28

TECHNICAL INFORMATION

Voltage (V)

12

Capacity C20 (Ah)

32

CCA -18°C EN (A)

350

RC (min)

48

LxWxH (mm)

196x127x159/185

Total Weight (kg)

8.0

BOX DESIGN

Box Type

U1

Cover Type

SMF

Colour

Black

Layout

1

BHD

B0

Terminal

5

DRAWING

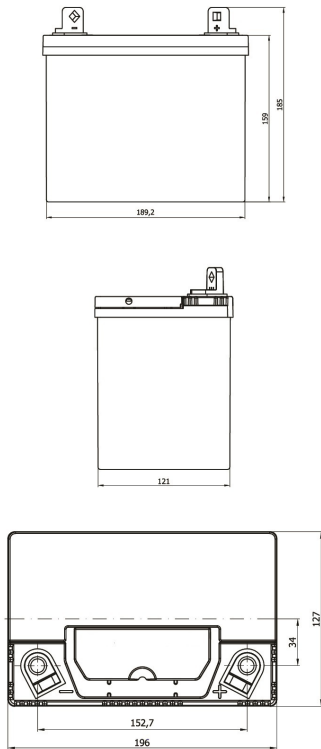

BHD



LAYOUT

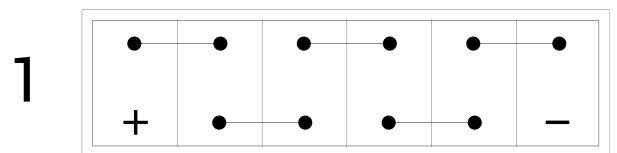

TERMINAL

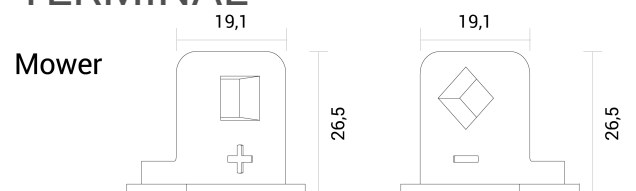

TECHNICAL DATASHEET

TAB MOWER U1-32